

DSSE

PRODUCT MANUAL



HYDRA BEAUTY BED BB02/BB13

Entry-Level Luxury with a Golden Touch

The Hydra beauty couch blends everyday functionality with a luxurious aesthetic, making it the perfect entry-level bed for brow and lash professionals. It features three adjustable sections to support a range of treatments. Its standout gold base adds a touch of glamour, while the fixed 70cm height ensures comfortable access and ergonomic working conditions. Designed to impress, built to perform.

Introduction

This manual is intended solely as a reference for the operation of this specific model. DSSE assumes no responsibility or liability for any consequences resulting from its use for other purposes. All information contained in this manual is protected by copyright and may not be copied, reproduced, or translated, in whole or in part, without the prior written consent of our company.

Safety Instructions

- Always ensure the bed is stable and positioned on a flat, level surface before use.
- Do not stand, jump, or apply excessive force to any part of the bed.
- Keep children away from the equipment and never leave them unattended around it.
- When leaving the bed unattended, always return the backrest and leg sections to their safest positions.
- Avoid placing the bed in damp or wet areas to prevent damage to the frame, upholstery, and mechanical parts.
- Avoid using the equipment in environments where painting, coating, or oxygen provision is taking place.
- Unless supervised or instructed by qualified personnel, people with physical disabilities, sensory disorders, mental impairments, lack of experience or common sense, and children are not permitted to use the equipment.
- If any part of the bed becomes damaged, loose, or unstable, discontinue use immediately and contact your distributor or a qualified technician for inspection or repair.
- Ensure there are no objects within the equipment's movement range during operation.
- All maintenance must be performed by trained professionals only.

Precautions

- This equipment should only be operated by trained or experienced personnel familiar with its structure and use.
- Read this manual carefully before installation, operation, and adjustment. Keep it for future reference.
- Do not apply weight unevenly or use the bed for single-side or single-point loading.
- Regularly check and tighten all bolts, screws, and nuts to prevent loosening caused by movement.
- Do not disassemble parts without proper authorization.
- If faults occur or abnormal noises are heard, stop usage immediately and have the equipment inspected.
- Only resume use after proper troubleshooting.
- Observe all warning labels (if any) on the product.
- Clean dust and stains using a neutral cleaning agent after each treatment.
- Keep hands, feet, and head clear of moving parts during adjustments.
- Always observe the maximum user weight capacity of the bed.
- Do not sit or apply heavy force on armrests, head or back sections. Refer to the weight limits in this manual.
- Ensure the locking mechanisms are fully engaged before the client lies down.
- For safety and stability, ensure the crossbars are installed exactly according to the installation guide.
- Clients must enter and exit the table from the middle section only.

ENTRY-LEVEL CARE, GOLD STANDARD

The Hydra Beauty Couch is a versatile, expertly crafted treatment bed trusted by beauty professionals and tattoo artists alike. Designed to accommodate brow and lash services, facials, and a wide range of advanced treatments, it delivers exceptional support and long-lasting comfort for both client and practitioner. Smooth adjustment functionality allows for precise positioning, ensuring ease of use throughout the day while maintaining optimal ergonomics.

Finished with an elegant champagne gold frame and plush, high-quality upholstery, the Hydra combines durability with refined aesthetics. Its sleek silhouette and premium detailing create a modern, polished presence, making it a standout feature in any high-end salon, clinic, or studio environment.



Adjustable Backrest (0° - 55°)

Manually adjustable by hand lever, the backrest allows you to customize the seating angle for optimal comfort and support.

Slot-in Armrests (removable)

The armrests support normal resting weight and can be easily removed for closer access during treatments.

Secure Support

Sturdy base resting on four black rubber feet for stability and mobility.

Large Face Hole

Enjoy extra comfort with a large breathing hole.

Ergonomic Comfort

Upholstered in PU vinyl with memory foam, it offers enhanced comfort and long-lasting durability.

Adjustable Legrest (0°-45°)

Manual hand lever adjustment for maximum comfort and support.

Crossbar Support

The bed includes two side-mounted crossbars for added strength and stability.

Product Specifications

Length:	184cm
Width without/with Arms:	60/80cm
Height:	70cm
Backrest Adjustment Angle:	Up to 55°
Legrest Adjustment Angle:	Up to 45°
Net Weight:	32 kg
Gross Weight:	36 kg
Max. Load Capacity:	150 kg (seating position)

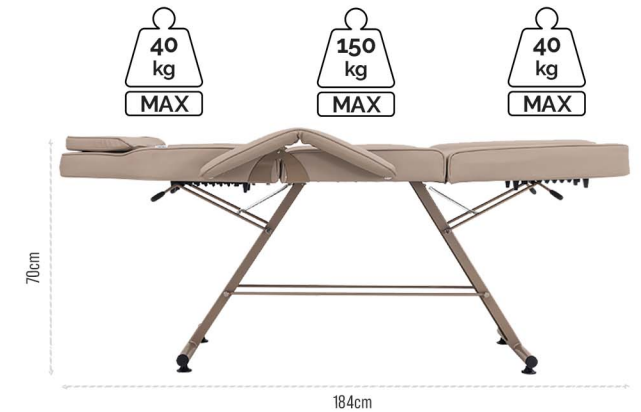

Style, Simplicity, and Salon-Ready Comfort







The Hydra beauty couch offers a streamlined solution for professionals seeking both functionality and style. Designed with three adjustable sections, it supports a variety of treatment positions while maintaining optimal comfort for both client and therapist. Upholstered in premium PU vinyl, the surface is smooth, durable, and easy to maintain. A fixed working height of 70cm promotes ergonomic efficiency, and the champagne gold base provides a clean, modern aesthetic suitable for any clinical or salon environment. Ideal as an entry-level option for brow and lash treatments.

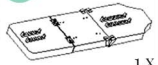

Leg and Backrest Adjustment

Both sections manually adjusted by hand lever

Installation Preparation: We recommend two (2) people for the installation of this beauty bed.

A  1 X 3 Section Bed Top	B  2 X Base Legs	C  2 X Cross Bars	D  1 X Spanner	E  2 X Arms	F  1 X Head Pillow
---	---	--	---	--	---

STEP 1

Ensure to **fully tighten** the 3 nuts on each leg (**B**) before proceeding to Step 2.

⚠ Failure to do so will result in incorrect installation of your beauty bed.

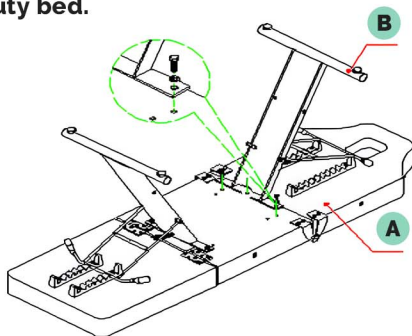

STEP 3

Connect the springs (**I**) on each side of the leg lever to the hole located in the base of each leg by stretching the spring.

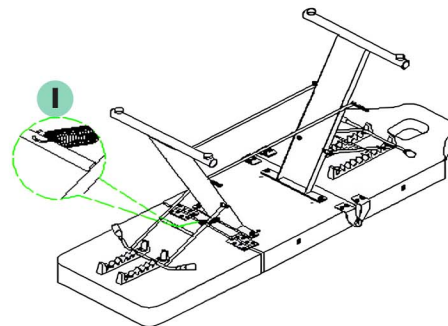

STEP 5

With the help of another person, carefully turn the bed over.

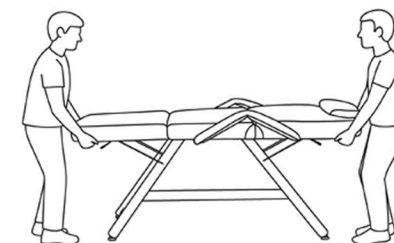

STEP 2

Place the crossbar (**C**) on one leg (**B1**). Please note you will need to stretch the opposite leg (**B2**) to install the other side of the crossbar. Repeat for second crossbar on other side of bed.

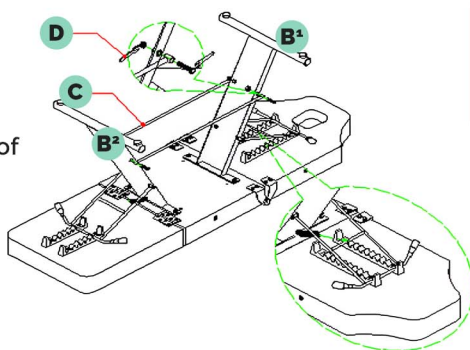

Warning: Take care when tightening screws to avoid cross-threading.

STEP 4

Slightly bend the arms (**E**) and insert them into the side of the bed. Insert the pillow (**F**) into the face hole. The bed is now ready for use.

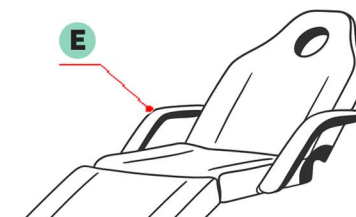

SAFETY WARNING: Do not allow children to operate this product. Always ensure that customers enter and exit the bed only from the middle section. Failure to follow these instructions may result in serious injury and damage to the bed.

Upholstery Care Guide

As a professional beautician, investing in a high quality facial bed can significantly enhance the comfort and effectiveness of your treatments. To maintain that level of performance and ensure long-term reliability, regular maintenance and proper care are essential. Like any professional equipment, your facial bed requires routine attention to stay in optimal working condition ensuring safety, smooth functionality, and a consistently elevated experience for your clients.

General Care Tips

Maintain a stable temperature:

- Cold can lead to vinyl cracking
- Heat may cause permanent stretching

Keep out of direct sunlight for long periods to prevent fading and damage. Regular housekeeping helps preserve comfort and appearance.



Cleaning Instructions

Clean frequently to remove body oils that can harden vinyl

Use a colorfast cloth dampened with lukewarm water and mild, alkaline-free soap

Avoid soaking the material

Wipe off any soap with fresh water and a clean cloth

Dry thoroughly with a soft, dry cloth

For tougher grime, gently scrub with a soft brush



Avoid Using These Products

- Hot or boiling water
- Alcohol or hydrocarbon-based cleaners
- Acetone
- Bleach or harsh detergents
- Furniture polish
- Abrasive powders, pastes, or steel wool
- Silicone or petroleum-based products
- Solvent-based or abrasive cleaning agents

Routine Inspection

Perform periodic checks on:

- Hinges • Fasteners • Structural components

Ensure your chair remains safe, stable, and fully functional.

Do not dispose of old or defective appliances with household waste. Please use designated public collection points for proper disposal. This manual is for reference only. Specifications may change without prior notice.

WARRANTY PERIOD

STANDARD: **1 YEAR** | VINYL: **2 YEARS**

For more information about our warranty, please refer to our website.

DSSE

Australia:

www.dsse.com.au

United Kingdom:

www.dssebeauty.co.uk

Europe:

www.dsseworld.com